

Aeroprakt Ltd.

24, Polevaya str., Kiev, Ukraine

Tel: 038 044 496-77-21

e-mail: aeroprakt.kiev@gmail.com

www.aeroprakt.kiev.ua

AEROPRAKT-32 (A32L)

Illustrated Parts Catalog

Иллюстрированный каталог частей

A32-(A32L)-IPC-10

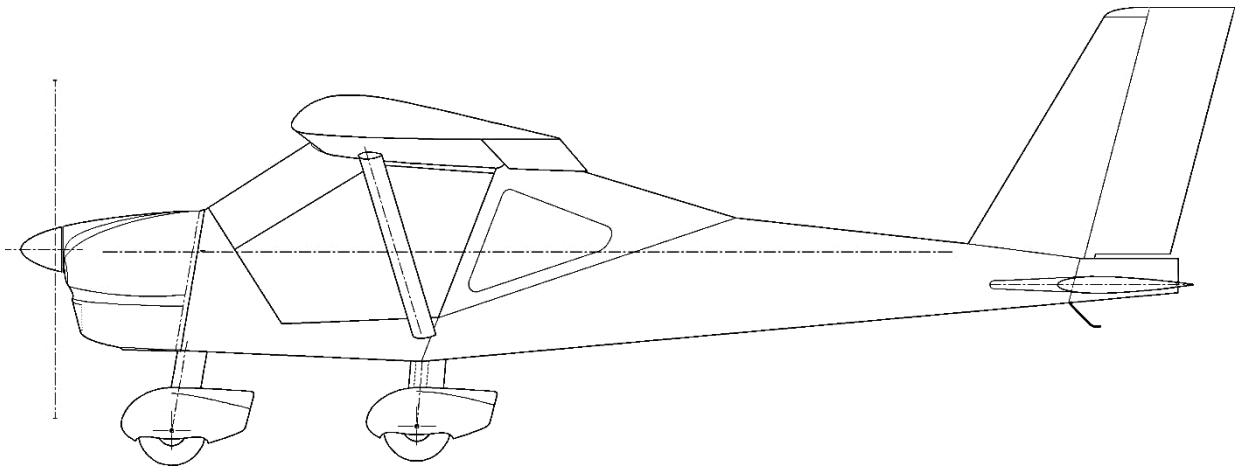

Contents / Содержание

INTRODUCTION / ВВЕДЕНИЕ	3
01. AIRFRAME / ПЛАНЕР	4
FUSELAGE / ФЮЗЕЛЯЖ.....	4
WING / КРЫЛО.....	8
HORIZONTAL EMPENNAGE / ГОРИЗОНТАЛЬНОЕ ОПЕРЕНИЕ	16
VERTICAL EMPENNAGE / ВЕРТИКАЛЬНОЕ ОПЕРЕНИЕ	18
GLASS / ОСТЕКЛЕНИЕ	19
DOORS / ДВЕРИ	20
02. LANDING GEAR / ШАССИ	21
NOSE LEG / ПЕРЕДНЯЯ СТОЙКА.....	21
MAIN LEG / ОСНОВНАЯ СТОЙКА	26
FAIRINGS / ОБТЕКАТЕЛИ	27
MUD-SCREENS / ЩИТКИ.....	28
WHEELS / КОЛЕСА	30
BRAKES / ТОРМОЗА	32
03. ENGINE AND ITS SYSTEMS / ДВИГАТЕЛЬ И ЕГО СИСТЕМЫ	34
ENGINE MOUNT / МОТОРАМА.....	34
CONTROL SYSTEM / СИСТЕМА УПРАВЛЕНИЯ	35
FUEL SYSTEM / ТОПЛИВНАЯ СИСТЕМА	40
OIL SYSTEM / МАСЛОСИСТЕМА	41
COOLING SYSTEM / СИСТЕМА ОХЛАЖДЕНИЯ.....	42
EXHAUST SYSTEM / ВЫХЛОПНАЯ СИСТЕМА	43
04. PROPELLER / ВОЗДУШНЫЙ ВИНТ.....	47
SPINNER / КОК.....	47
PROPELLER / ВИНТ	48
05. AIRPLANE CONTROL SYSTEM / СИСТЕМА УПРАВЛЕНИЯ САМОЛЕТОМ	49
CONTROL SYSTEM LEVERS / ПОСТЫ СИСТЕМЫ УПРАВЛЕНИЯ.....	49
AILERON CONTROL SYSTEM / СИСТЕМА УПРАВЛЕНИЯ ЭЛЕРОНАМИ	55
ELEVATOR CONTROL SYSTEM / СИСТЕМА УПРАВЛЕНИЯ РУ	57
RUDDER CONTROL SYSTEM / СИСТЕМА УПРАВЛЕНИЯ РН.....	59
AUTOPILOT / АВТОПИЛОТ	60
06. ELECTRICAL SYSTEM / ЭЛЕКТРОСИСТЕМА.....	62
ELECTRICAL EQUIPMENT / ЭЛЕКТРООБОРУДОВАНИЕ.....	62
INSTRUMENTS / ПРИБОРНОЕ ОБОРУДОВАНИЕ	64
07. SOCRIT EQUIPMENT / ОБОРУДОВАНИЕ КАБИНЫ.....	66
SEATS / СИДЕНЬЯ	66
HARNES BELTS / ПРИВЯЗНАЯ СИСТЕМА	68
INTERIOR AND BAGGAGE COMPARTMENT / ИНТЕРЬЕР И БАГАЖНИК	69
08. CONSUMABLE MATERIALS / РАСХОДНЫЕ МАТЕРИАЛЫ	70
CATALOG STRUCTURE / СТРУКТУРА КАТАЛОГА.....	72

INTRODUCTION / ВВЕДЕНИЕ

Significance of the catalog number (PART NO.) symbols:

Значение цифр каталожного номера (НОМЕР):

A32x-AB-CDEF G

- A32x** - airplane type / тип самолета: **A32/A32L**;
- AB** - catalog chapter number / номер раздела каталога;
- CDEF** - item number within catalog chapter / номер позиции в разделе каталога
- G** - version: «R» - right-hand, «L» - left-hand, or omitted if not “handed” /
исполнение: «R» - правое, «L» - левое, либо отсутствует.

01. AIRFRAME / ПЛАНЕР

Fuselage / Фюзеляж

	<p>NAME: Fuselage with fin, unpainted, assembled by agreement (A32 only). Provide S/N. PART NO.: A32-01-0001 WEIGHT: 47.4 kg</p>
	<p>NAME: Fuselage with fin, unpainted, assembled by agreement (A32L only). Provide S/N. PART NO.: A32L-01-0001 WEIGHT: 44.67 kg</p>
	<p>NAME: Tail boom assembly, unpainted. PART NO.: A32-01-0002 WEIGHT: 10.74 kg</p>
	<p>NAME: Top cowling, R912UL(ULS), unpainted. PART NO.: A32-01-0003 WEIGHT: 1.435 kg</p>
	<p>НАИМЕН.: Верхняя часть капота, R912UL/ULS, неокрашенная. НОМЕР: A32-01-0003 ВЕС: 1.435 кг</p>

	<p>NAME: Top cowling, R912UL/ULS, painted. Provide S/N. PART NO.: A32-01-0004 WEIGHT: 1.585 kg</p>
	<p>НАИМЕН.: Верхняя часть капота, R912UL/ULS, окрашенная. Сообщите S/N. НОМЕР: A32-01-0004 ВЕС: 1.585 кг</p>
	<p>NAME: Bottom cowling, unpainted. PART NO.: A32-01-0005 WEIGHT: 1.728 kg</p>
	<p>НАИМЕН.: Нижняя часть капота, неокрашенная. НОМЕР: A32-01-0005 ВЕС: 1.728 кг</p>
	<p>NAME: Bottom cowling, painted. Provide S/N. PART NO.: A32-01-0006 WEIGHT: 1.89 kg</p>
	<p>НАИМЕН.: Нижняя часть капота, окрашенная. Сообщите S/N. НОМЕР: A32-01-0006 ВЕС: 1.89 кг</p>
	<p>NAME: Cowling lock pin set. PART NO.: A32-01-0014 WEIGHT: 0.029 kg</p>
	<p>НАИМЕН.: Комплект штифтов замков капота. НОМЕР: A32-01-0014 ВЕС: 0.029 кг</p>

	<p>NAME: Cowling lock socket set. PART NO.: A32-01-0015 WEIGHT: 0.045 kg</p>
	<p>НАИМЕН.: Комплект гнезд замков капота. НОМЕР: A32-01-0015 ВЕС: 0.045 кг</p> <p>NAME: Firewall assembly, R912UL/ULS, unpainted. PART NO.: A32-01-0007 WEIGHT: 4.04 kg</p>
	<p>НАИМЕН.: Первый шпангоут в сборе, R912UL/ULS, неокрашенный. НОМЕР: A32-01-0007 ВЕС: 4.04 кг</p> <p>NAME: Floor panel, forward, unpainted. PART NO.: A32-01-0008 WEIGHT: 1.918 kg</p>
	<p>НАИМЕН.: Панель пола, передняя, неокрашенная. НОМЕР: A32-01-0008 ВЕС: 1.918 кг</p> <p>NAME: Frame No. 10. PART NO.: A32-01-0009 WEIGHT: 0.262 kg</p> <p>НАИМЕН.: Шпангоут №10. НОМЕР: A32-01-0009 ВЕС: 0.262 кг</p>



	<p>NAME: Stabilator hinge brackets (a set). PART NO.: A32-01-0011 WEIGHT: 0.158 kg</p>
	<p>NAME: Tail skid. PART NO.: A32-01-0010 WEIGHT: 0.21 kg</p>
	<p>NAME: Tail fairing, unpainted. PART NO.: A32-01-0012 WEIGHT: 0.38 kg</p>
	<p>NAME: Tail fairing, painted. Provide S/N. PART NO.: A32-01-0013 WEIGHT: 0.415 kg</p>
	<p>НАИМЕН.: Стекатель, неокрашенный. НОМЕР: A32-01-0012 ВЕС: 0.38 кг</p>
	<p>НАИМЕН.: Стекатель, окрашенный. Сообщите S/N. НОМЕР: A32-01-0013 ВЕС: 0.415 кг</p>



Wing / Крыло

	<p>NAME: Outer wing, not covered (A32 only). PART NO.: A32-01-1000 R A32-01-1000 L WEIGHT: 21.1 kg</p> <hr/> <p>НАИМЕН.: Консоль крыла, не обтянутая (только для А32). НОМЕР: A32-01-1000 R A32-01-1000 L ВЕС: 21.1 кг</p>
	<p>NAME: Outer wing, painted (A32 only). Provide S/N. PART NO.: A32-01-1001 R A32-01-1001 L WEIGHT: 23.4 kg</p> <hr/> <p>НАИМЕН.: Консоль крыла, окрашенная (только для А32). Сообщите S/N. НОМЕР: A32-01-1001 R A32-01-1001 L ВЕС: 23.4 кг</p>
	<p>NAME: Outer wing, not covered (A32L only). PART NO.: A32L-01-1000 R A32L-01-1000 L WEIGHT: 16.7 kg</p> <hr/> <p>НАИМЕН.: Консоль крыла, не обтянутая (только для А32L). НОМЕР: A32L-01-1000 R A32L-01-1000 L ВЕС: 16.7 кг</p>
	<p>NAME: Outer wing, painted (A32L only). Provide S/N. PART NO.: A32L-01-1001 R A32L-01-1001 L WEIGHT: 18.8 kg</p> <hr/> <p>НАИМЕН.: Консоль крыла, окрашенная (только для А32L). Сообщите S/N. НОМЕР: A32L-01-1001 R A32L-01-1001 L ВЕС: 18.8 кг</p>



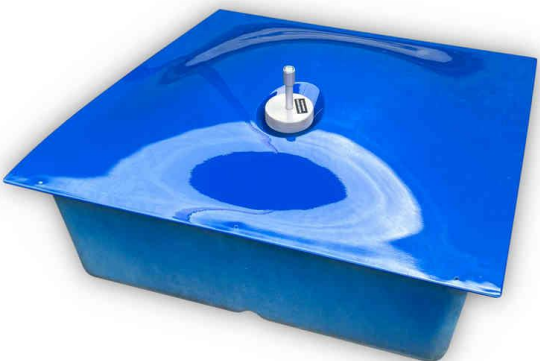

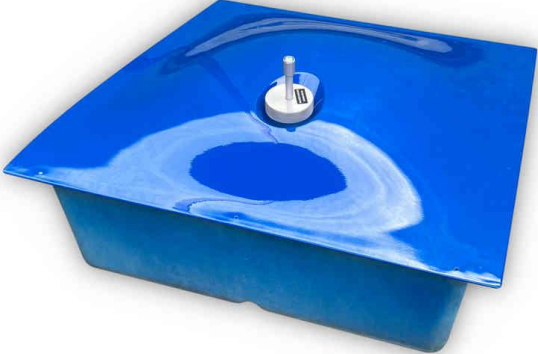
	<p>NAME: Flaperon hinge bracket bearings (a set). PART NO.: A22LS-01-1002 WEIGHT: 0.021 kg</p>
	<p>НАИМЕН.: Втулки кронштейнов навески флаперона (комплект). НОМЕР: A22LS-01-1002 ВЕС: 0.021 кг</p>
	<p>NAME: Flaperon, not covered. PART NO.: A32-01-1002 R A32-01-1002 L WEIGHT: 3.3 kg</p>
	<p>НАИМЕН.: Флаперон, не обтянутый. НОМЕР: A32-01-1002 R A32-01-1002 L ВЕС: 3.3 кг</p>
	<p>NAME: Flaperon, painted. Provide S/N. PART NO.: A32-01-1003 R A32-01-1003 L WEIGHT: 4.3 kg</p>
	<p>НАИМЕН.: Флаперон, окрашенный. Сообщите S/N. НОМЕР: A32-01-1003 R A32-01-1003 L ВЕС: 4.3 кг</p>
	<p>NAME: Flaperon trim tab, unpainted. PART NO.: A22LS-01-1005 WEIGHT: 0.025 kg</p>
	<p>НАИМЕН.: Триммер флаперона, неокрашенный. НОМЕР: A22LS-01-1005 ВЕС: 0.025 кг</p>

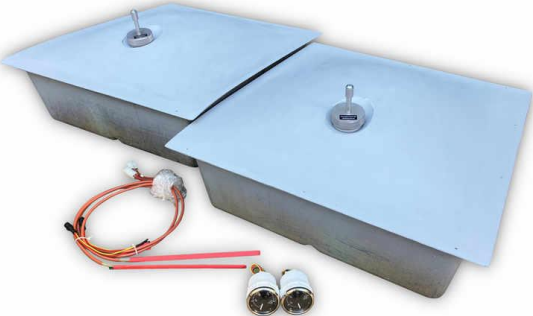
	<p>NAME: Flaperon trim tab, painted. Provide S/N. PART NO.: A22LS-01-1006 WEIGHT: 0.03 kg</p>
	<p>НАИМЕН.: Триммер флаперона, окрашенный. Сообщите S/N. НОМЕР: A22LS-01-1006 ВЕС: 0.03 кг</p>
	<p>NAME: R912UL/ULS fuel tank 45 l, unpainted. Valid from A32 S/N 074, A32L S/N 022 inclusive. PART NO.: A22LS-01-1007 R A22LS-01-1007 L WEIGHT: 2.986 kg</p>
	<p>НАИМЕН.: Бак топливный 45 л R912UL/ULS, неокрашенный. Действует с A32 S/N 074, A32L S/N 022 включительно. НОМЕР: A22LS-01-1007 R A22LS-01-1007 L ВЕС: 2.986 кг</p>
	<p>NAME: R912iS fuel tank 45 l, unpainted. Valid from A32 S/N 074, A32L S/N 022 inclusive. PART NO.: A22LS-01-1016 R A22LS-01-1016 L WEIGHT: 3.028 kg</p>
	<p>НАИМЕН.: Бак топливный 45 л R912iS, неокрашенный. Действует с A32 S/N 074, A32L S/N 022 включительно. НОМЕР: A22LS-01-1016 R A22LS-01-1016 L ВЕС: 3.028 кг</p>
 IMAGE COMING SOON	<p>NAME: R912UL/ULS fuel tank 45 l, painted. Valid from A32 S/N 074, A32L S/N 022 inclusive. Provide S/N. PART NO.: A22LS-01-1017 R A22LS-01-1017 L WEIGHT: 3.031 kg</p>
	<p>НАИМЕН.: Бак топливный 45 л R912UL/ULS, окрашенный. Действует с A32 S/N 074, A32L S/N 022 включительно. Сообщите S/N. НОМЕР: A22LS-01-1017 R A22LS-01-1017 L ВЕС: 3.031 кг</p>

	<p>NAME: R912iS fuel tank 45 l, painted. Valid from A32 S/N 074, A32L S/N 022 inclusive. Provide S/N. PART NO.: A22LS-01-1018 R A22LS-01-1018 L WEIGHT: 3.073 kg</p>
	<p>НАИМЕН.: Бак топливный 45 л R912iS, окрашенный. Действует с A32 S/N 074, A32L S/N 022 включительно. Сообщите S/N. НОМЕР: A22LS-01-1018 R A22LS-01-1018 L ВЕС: 3.073 кг</p>
	<p>NAME: R912UL/ULS fuel tank 57 l, unpainted. Valid from A32 S/N 074, A32L S/N 022 inclusive. PART NO.: A22LS-01-1019 R A22LS-01-1019 L WEIGHT: 2.863 kg</p>
	<p>НАИМЕН.: Бак топливный 57 л R912UL/ULS, неокрашенный. Действует с A32 S/N 074, A32L S/N 022 включительно. НОМЕР: A22LS-01-1019 R A22LS-01-1019 L ВЕС: 2.863 кг</p>
	<p>NAME: R912iS fuel tank 57 l, unpainted. Valid from A32 S/N 074, A32L S/N 022 inclusive. PART NO.: A22LS-01-1020 R A22LS-01-1020 L WEIGHT: 2.905 kg</p>
	<p>НАИМЕН.: Бак топливный 57 л R912iS, неокрашенный. Действует с A32 S/N 074, A32L S/N 022 включительно. НОМЕР: A22LS-01-1020 R A22LS-01-1020 L ВЕС: 2.905 кг</p>
	<p>NAME: R912UL/ULS fuel tank 57 l, painted. Valid from A32 S/N 074, A32L S/N 022 inclusive. Provide S/N. PART NO.: A22LS-01-1021 R A22LS-01-1021 L WEIGHT: 2.908 kg</p>
	<p>НАИМЕН.: Бак топливный 57 л R912UL/ULS, окрашенный. Действует с A32 S/N 074, A32L S/N 022 включительно. Сообщите S/N. НОМЕР: A22LS-01-1021 R A22LS-01-1021 L ВЕС: 2.908 кг</p>



	<p>NAME: R912iS fuel tank 57 l, painted. Valid from A32 S/N 074, A32L S/N 022 inclusive. Provide S/N. PART NO.: A22LS-01-1022 R A22LS-01-1022 L WEIGHT: 2.950 kg</p>
	<p>NAME: Retrofit set of R912UL/ULS fuel tanks 45 l, unpainted. Valid up to A32 S/N 073, A32L S/N 021 inclusive. PART NO.: A32-01-1009 WEIGHT: 6.138 kg</p>
	<p>NAME: Retrofit set of R912UL/ULS fuel tanks 45 l, painted. Valid up to A32 S/N 073, A32L S/N 021 inclusive. Provide S/N. PART NO.: A32-01-1010 WEIGHT: 6.228 kg</p>
	<p>NAME: Retrofit set of R912UL/ULS fuel tanks 57 l, unpainted. Valid up to A32 S/N 073, A32L S/N 021 inclusive. PART NO.: A32-01-1011 WEIGHT: 5,892 kg</p>
	<p>НАИМЕН.: Ретрофит комплект топливных баков 57 л R912UL/ULS, неокрашенный. Действует до A32 S/N 073, A32L S/N 021 включительно. НОМЕР: A32-01-1011 ВЕС: 5,892 кг</p>



	<p>NAME: Retrofit set of R912UL/ULS fuel tanks 57 l, painted. Valid up to A32 S/N 073, A32L S/N 021 inclusive. Provide S/N. PART NO.: A32-01-1012 WEIGHT: 5,982 kg</p>
	<p>NAME: Fuel tank cap. PART NO.: A22LS-01-1008 WEIGHT: 0.075 kg</p>
	<p>NAME: Wing strut, painted. Provide S/N. PART NO.: A32-01-1004 R A32-01-1004 L WEIGHT: 3.6 kg</p>
	<p>NAME: Wing strut fairings, painted (a set). Provide S/N. PART NO.: A32-01-1005 WEIGHT: 0.96 kg</p> <p>НАИМЕН.: Обтекатели подкосов, окрашенные (комплект). Сообщите S/N. НОМЕР: A32-01-1005 ВЕС: 0.96 кг</p>

	<p>NAME: Pitot tube. PART NO.: A32-01-1006 WEIGHT: 0.3 kg</p>
	<p>НАИМЕН.: Приемник воздушного давления. НОМЕР: A32-01-1006 ВЕС: 0.3 кг</p>
	<p>NAME: Pitot tube with angle attack sensor. PART NO.: A32-01-1007 WEIGHT: 0.32 kg</p>
	<p>НАИМЕН.: Приемник воздушного давления с датчиком угла атаки. НОМЕР: A32-01-1007 ВЕС: 0.32 кг</p>
	<p>NAME: Wing covering, DIATEX fabric. PART NO.: A22LS-01-1013 WEIGHT: 0.18 kg</p>
	<p>НАИМЕН.: Обшивка крыла (ткань DIATEX). НОМЕР: A22LS-01-1013 ВЕС: 0.18 кг</p>
	<p>NAME: Wing covering, upper, DIATEX fabric, (A32L only). PART NO.: A22L2-01-1002 WEIGHT: 0.22 kg</p>
	<p>НАИМЕН.: Обшивка крыла верхняя, ткань DIATEX (только для A32L). НОМЕР: A22L2-01-1002 ВЕС: 0.22 кг</p>

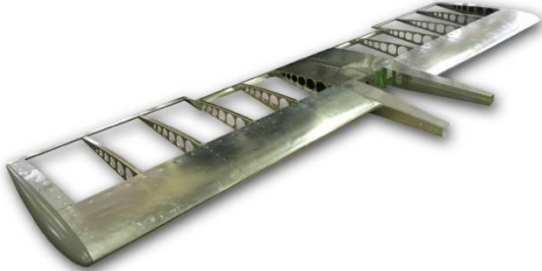

	<p>NAME: Flaperon covering, DIATEX fabric. PART NO.: A22LS-01-1014 WEIGHT: 0.27 kg</p> <p>НАИМЕН.: Обшивка флаперона, ткань DIATEX. НОМЕР: A22LS-01-1014 ВЕС: 0.27 кг</p>
	<p>NAME: Tie-down rings. Valid from A32 S/N 067, A32L S/N 023 inclusive. PART NO.: A22LS-01-1015 WEIGHT: 0.1 kg</p> <p>НАИМЕН.: Швартовочные проушины. Действует с A32 S/N 067 и A32L S/N 023 включительно. НОМЕР: A22LS-01-1015 ВЕС: 0.1 кг</p>
	<p>NAME: Set of fasteners for installation of outer wings and wing struts. PART NO.: A32-01-1008 WEIGHT: 0.222 kg</p> <p>НАИМЕН.: Комплект крепежа для установки консолей крыла и подкосов. НОМЕР: A32-01-1008 ВЕС: 0.222 кг</p>

Horizontal empennage / Горизонтальное оперение

	<p>NAME: Stabilator, not covered PART NO.: A32-01-2000 WEIGHT: 6.9 kg</p>
	<p>НАИМЕН.: Цельноповоротное горизонтальное оперение (ЦПГО), не обтянутое. НОМЕР: A32-01-2000 ВЕС: 6.9 кг</p>
	<p>NAME: Stabilator, painted. Provide S/N. PART NO.: A32-01-2001 WEIGHT: 8.1 kg</p>
	<p>НАИМЕН.: Цельноповоротное горизонтальное оперение (ЦПГО), окрашенное. Сообщите S/N. НОМЕР: A32-01-2001 ВЕС: 8.1 кг</p>
	<p>NAME: Stabilator trim tab, unpainted. PART NO.: A32-01-2002 WEIGHT: 0.35 kg</p>
	<p>НАИМЕН.: Триммер ЦПГО, неокрашенный. НОМЕР: A32-01-2002 ВЕС: 0.35 кг</p>
	<p>NAME: Stabilator trim tab, painted. Provide S/N. PART NO.: A32-01-2003 WEIGHT: 0.4 kg</p>
	<p>НАИМЕН.: Триммер ЦПГО, окрашенный. Сообщите S/N. НОМЕР: A32-01-2003 ВЕС: 0.4 кг</p>

	<p>NAME: Stabilator covering (DIATEX fabric). PART NO.: A32-01-2004 WEIGHT: 0.6 kg</p>
	<p>НАИМЕН.: Обшивка ЦПГО (ткань DIATEX). НОМЕР: A32-01-2004 ВЕС: 0.6 кг</p>
	<p>NAME: Stabilator fasteners. PART NO.: A32-01-2005 WEIGHT: 0.05 kg</p>
	<p>НАИМЕН.: Крепеж навески ЦПГО. НОМЕР: A32-01-2005 ВЕС: 0.05 кг</p>

Vertical empennage / Вертикальное оперение

	<p>NAME: Set of fin parts, unpainted. PART NO.: A32-01-3000 WEIGHT: 2.8 kg</p>
	<p>НАИМЕН.: Набор деталей кия, неокрашенный. НОМЕР: A32-01-3000 ВЕС: 2.8 кг</p>
	<p>NAME: Rudder, not covered. PART NO.: A32-01-3001 WEIGHT: 1.1 kg</p>
	<p>НАИМЕН.: Руль направления, не обтянутый. НОМЕР: A32-01-3001 ВЕС: 1.1 кг</p>
	<p>NAME: Rudder, painted. Provide S/N. PART NO.: A32-01-3002 WEIGHT: 1.4 kg</p>
	<p>НАИМЕН.: Руль направления, окрашенный. Сообщите S/N. НОМЕР: A32-01-3002 ВЕС: 1.4 кг</p>
	<p>NAME: Rudder covering (DIATEX fabric). PART NO.: A22LS-01-3003 WEIGHT: 0.13 kg</p>
	<p>НАИМЕН.: Обшивка руля направления (ткань DIATEX). НОМЕР: A22LS-01-3003 ВЕС: 0.13 кг</p>

Glass / Остекление





	<p>NAME: PET windscreens glass (S=2мм.). Valid up to A32 S/N 100, A32L S/N 025 inclusive. PART NO.: A32-01-4002 WEIGHT: 2.6 kg</p>
	<p>НАИМЕН.: Лобовое стекло PET (S=2мм.). Действует до A32 S/N 100, A32L S/N 025 включительно. НОМЕР: A32-01-4002 ВЕС: 2.6 кг</p>
	<p>NAME: Acrylic windscreens glass (S=3мм.). Valid from A32 S/N 101, A32L S/N 026 inclusive. PART NO.: A32-01-4003 WEIGHT: 3.8 kg</p>
	<p>НАИМЕН.: Акриловое лобовое стекло (S=3мм.). Действует с A32 S/N 101, A32L S/N 026 включительно. НОМЕР: A32-01-4003 ВЕС: 3.8 кг</p>
	<p>NAME: PET windscreens glass edging, painted. Valid up to A32 S/N 100, A32L S/N 025 inclusive. Provide S/N. PART NO.: A32-01-4004 WEIGHT: 0.29 kg</p>
	<p>НАИМЕН.: Панки для лобового стекла PET, окрашенные. Действует до A32 S/N 100, A32L S/N 025 включительно. Сообщите S/N. НОМЕР: A32-01-4004 ВЕС: 0.29 кг</p>
	<p>NAME: Acrylic windscreens glass edging, painted. Valid from A32 S/N 101, A32L S/N 026 inclusive. Provide S/N. PART NO.: A32-01-4005 WEIGHT: 0.29 kg</p>
	<p>НАИМЕН.: Панки для акрилового лобового стекла, окрашенные. Действует с A32 S/N 101, A32L S/N 026 включительно. Сообщите S/N. НОМЕР: A32-01-4005 ВЕС: 0.29 кг</p>

Doors / Двери

	<p>NAME: Door, painted. Valid from A32 S/N 031, A32L S/N 007 inclusive. Provide S/N. PART NO.: A32-01-5000 R A32-01-5000 L WEIGHT: 3.7 kg</p> <p>НАИМЕН.: Дверь, окрашенная. Действует с A32 S/N 031, A32L S/N 007 включительно. Сообщите S/N. НОМЕР: A32-01-5000 R A32-01-5000 L ВЕС: 3.7 кг</p>
	<p>NAME: Door glass with the vent scoop. Valid from A32 S/N 235, A32L S/N 026 inclusive. PART NO.: A32-01-5001 R A32-01-5001 L WEIGHT: 1.82 kg</p> <p>НАИМЕН.: Стекло двери с форточкой. Действует с A32 S/N 235, A32L S/N 026 включительно. НОМЕР: A32-01-5001 R A32-01-5001 L ВЕС: 1.82 кг</p>
	<p>NAME: Vent scoop. PART NO.: A22LS-01-5003 WEIGHT: 0.02 kg</p> <p>НАИМЕН.: Форточка. НОМЕР: A22LS-01-5003 ВЕС: 0.02 кг</p>
	<p>NAME: Gas strut. PART NO.: A22LS-01-5004 WEIGHT: 0.25 kg</p> <p>НАИМЕН.: Газовая пружина. НОМЕР: A22LS-01-5004 ВЕС: 0.25 кг</p>

02. LANDING GEAR / ШАССИ

Nose leg / Передняя стойка

	<p>NAME: Nose landing gear leg 15x6x6, primed. PART NO.: A32-02-0004 WEIGHT: 4.947 kg</p>
	<p>НАИМЕН.: Передняя стойка шасси 15x6x6, грунтованная. НОМЕР: A32-02-0004 ВЕС: 4.947 кг</p>
	<p>NAME: Nose landing gear leg 15x6x6, painted. Provide S/N. PART NO.: A32-02-0001 WEIGHT: 4.962 kg</p>
	<p>НАИМЕН.: Передняя стойка шасси 15x6x6, окрашенная. Сообщите S/N. НОМЕР: A32-02-0001 ВЕС: 4.962 кг</p>
	<p>NAME: Nose landing gear leg 8x6, primed. PART NO.: A32-02-0005 WEIGHT: 5.899 kg</p>
	<p>НАИМЕН.: Передняя стойка шасси 8x6, грунтованная. НОМЕР: A32-02-0005 ВЕС: 5.899 кг</p>
	<p>NAME: Nose landing gear leg 8x6, painted. Provide S/N. PART NO.: A32-02-0006 WEIGHT: 5.914 kg</p>
	<p>НАИМЕН.: Передняя стойка шасси 8x6, окрашенная. Сообщите S/N. НОМЕР: A32-02-0006 ВЕС: 5.914 кг</p>

	<p>NAME: Nose landing gear leg 6x6, primed. PART NO.: A32-02-0010 WEIGHT: 5.687 kg</p>
	<p>НАИМЕН.: Передняя стойка шасси 6x6, грунтованная. НОМЕР: A32-02-0010 ВЕС: 5.687 кг</p>
 <p>IMAGE COMING SOON</p>	<p>NAME: Nose landing gear leg 6x6, painted. Provide S/N. PART NO.: A32-02-0011 WEIGHT: 5.702 kg</p>
	<p>НАИМЕН.: Передняя стойка шасси 6x6, окрашенная. Сообщите S/N. НОМЕР: A32-02-0011 ВЕС: 5.702 кг</p>
	<p>NAME: Nose wheel fork 15x6x6. PART NO.: A22LS-02-0002 WEIGHT: 2.304 kg</p>
	<p>НАИМЕН.: Вилка передней стойки 15x6x6. НОМЕР: A22LS-02-0002 ВЕС: 2.304 кг</p>
	<p>NAME: Nose wheel fork 8x6. PART NO.: A22LS-02-0013 WEIGHT: 3.179 kg</p>
	<p>НАИМЕН.: Вилка передней стойки 8x6. НОМЕР: A22LS-02-0013 ВЕС: 3.179 кг</p>

	<p>NAME: Nose wheel fork 6x6. PART NO.: A22LS-02-0024 WEIGHT: 3.087 kg</p>
	<p>НАИМЕН.: Вилка передней стойки 6х6. НОМЕР: A22LS-02-0024 ВЕС: 3.087 кг</p>
	<p>NAME: 15x6x6 Nose landing gear strut with bellcrank, primed. PART NO A32-02-0007 WEIGHT: 2.104 kg</p>
	<p>НАИМЕН.: Рычаг передней стойки 15х6х6 с качалкой, грунтованный. НОМЕР: A32-02-0007 ВЕС: 2.104 кг</p>
	<p>NAME: 15x6x6 Nose landing gear strut with bellcrank, painted. Provide S/N. PART NO A32-02-0002 WEIGHT: 2.119 kg</p>
	<p>НАИМЕН.: Рычаг передней стойки 15х6х6 с качалкой, окрашенный. Сообщите S/N. НОМЕР: A32-02-0002 ВЕС: 2.119 кг</p>
	<p>NAME: 8x6 Nose landing gear strut with bellcrank, primed (fits the strut with 6x6 Airtrac wheel). PART NO A32-02-0008 WEIGHT: 2.066 kg</p>
	<p>НАИМЕН.: Рычаг передней стойки 8х6 с качалкой, грунтованный (подходит для стойки с колесом 6х6 Airtrac). НОМЕР: A32-02-0008 ВЕС: 2.066 кг</p>

	<p>NAME: 8x6 Nose landing gear strut with bellcrank, painted (fits the strut with 6x6 Airtrac wheel). Provide S/N. PART NO A32-02-0009 WEIGHT: 2.081 kg</p>
	<p>NAME: Bracket, forward. PART NO A22LS-02-0020 WEIGHT: 0.127 kg</p>
	<p>NAME: Bracket, rear. PART NO A22LS-02-0021 WEIGHT: 0.051 kg</p>
	<p>NAME: Spring shock absorber. PART NO.: A22LS-02-0004 WEIGHT: 0.39 kg</p>
	<p>НАИМЕН.: Рычаг передней стойки 8x6 с качалкой, окрашенный (подходит для стойки с колесом 6x6 Airtrac). Сообщите S/N. НОМЕР: A32-02-0009 ВЕС: 2.081 кг</p> <p>НАИМЕН.: Кронштейн, передний. НОМЕР: A22LS-02-0020 ВЕС: 0.127 кг</p> <p>НАИМЕН.: Кронштейн, задний. НОМЕР: A22LS-02-0021 ВЕС: 0.051 кг</p> <p>NAME: Spring shock absorber. PART NO.: A22LS-02-0004 WEIGHT: 0.39 kg</p> <p>НАИМЕН.: Пружинный амортизатор. НОМЕР: A22LS-02-0004 ВЕС: 0.39 кг</p>





NAME: **Nose landing gear strut support assembly, unpainted.**
PART NO.: **A32-02-0003**
WEIGHT: **0.8 kg**

НАИМЕН.: **Опора передней стойки в сборе, неокрашенная.**
НОМЕР: **A32-02-0003**
ВЕС: **0.8 кг**

Main leg / Основная стойка

	<p>NAME: Main landing gear leg with 6x6(8x6) wheel axle, unpainted. PART NO.: A22LS-02-1001 WEIGHT: 3.851 kg</p>
	<p>НАИМЕН.: Основная стойка с осью 6x6(8x6), неокрашенная. НОМЕР: A22LS-02-1001 ВЕС: 3.851 кг</p>
	<p>NAME: Main landing gear leg with 6x6(8x6) wheel axle, painted. Provide S/N. PART NO.: A22LS-02-1000 WEIGHT: 3.881 kg</p>
	<p>НАИМЕН.: Основная стойка в сборе 6x6(8x6), окрашенная. Сообщите S/N. НОМЕР: A22LS-02-1000 ВЕС: 3.881 кг</p>
	<p>NAME: Fasteners for installation of A32 main landing gear. PART NO.: A32-02-1000 WEIGHT: 0.153 kg</p>
	<p>НАИМЕН.: Крепеж для установки основной стойки А32. НОМЕР: A32-02-1000 ВЕС: 0.153 кг</p>

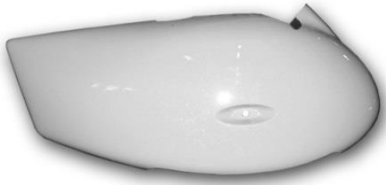
Fairings / Обтекатели

	<p>NAME: Nose wheel fairing, unpainted. PART NO.: A32-02-2000 WEIGHT: 0.75 kg</p> <hr/> <p>НАИМЕН.: Обтекатель носового колеса, неокрашенный. НОМЕР: A32-02-2000 ВЕС: 0.75 кг</p>
	<p>NAME: Nose wheel fairing, painted. Provide S/N. PART NO.: A32-02-2001 WEIGHT: 0.8 kg</p> <hr/> <p>НАИМЕН.: Обтекатель носового колеса, окрашенный. Сообщите S/N. НОМЕР: A32-02-2001 ВЕС: 0.8 кг</p>
	<p>NAME: Main wheel fairing, unpainted. PART NO.: A22LS-02-2002 R A22LS-02-2002 L WEIGHT: 0.65 kg</p> <hr/> <p>НАИМЕН.: Обтекатель основного колеса, неокрашенный. НОМЕР: A22LS-02-2002 R A22LS-02-2002 L ВЕС: 0.65 кг</p>
	<p>NAME: Main wheel fairing, painted. Provide S/N. PART NO.: A22LS-02-2003 R A22LS-02-2003 L WEIGHT: 0.7 kg</p> <hr/> <p>НАИМЕН.: Обтекатель основного колеса, окрашенный. Сообщите S/N. НОМЕР: A22LS-02-2003 R A22LS-02-2003 L ВЕС: 0.7 кг</p>

Mud-screens / Щитки

	<p>NAME: Cheng shin 15x6x6 nose wheel mud-screen. PART NO A22LS-02-3000 WEIGHT: 0.276 kg</p> <hr/> <p>НАИМЕН.: Щиток носового колеса 15x6x6 Cheng shin. НОМЕР: A22LS-02-3000 ВЕС: 0.276 кг</p>
	<p>NAME: Airtrac 15x6x6 nose wheel mud-screen. PART NO A22LS-02-3002 WEIGHT: 0.266 kg</p> <hr/> <p>НАИМЕН.: Щиток носового колеса 15x6x6 Airtrac. НОМЕР: A22LS-02-3002 ВЕС: 0.266 кг</p>
	<p>NAME: Carlisle-Tyre 8x6 nose wheel mud-screen. PART NO A22LS-02-3003 WEIGHT: 0.382 kg</p> <hr/> <p>НАИМЕН.: Щиток носового колеса 8x6 Carlisle-Tyre. НОМЕР: A22LS-02-3003 ВЕС: 0.382 кг</p>
	<p>NAME: Airtrac 6x6 nose wheel mud-screen. PART NO A22LS-02-3006 WEIGHT: 0.315 kg</p> <hr/> <p>НАИМЕН.: Щиток носового колеса 6x6 Airtrac. НОМЕР: A22LS-02-3006 ВЕС: 0.315 кг</p>

	<p>NAME: Cheng shin 15x6x6 main wheel mud-screen. PART NO.: A22LS-02-3001 R A22LS-02-3001 L WEIGHT: 0.444 kg</p>
	<p>NAME: Airtrac 15x6x6 main wheel mud-screen. PART NO.: A22LS-02-3004 R A22LS-02-3004 L WEIGHT: 0.444 kg</p>
	<p>NAME: Carlisle-Tyre 8x6 main wheel mud-screen. PART NO.: A22LS-02-3005 R A22LS-02-3005 L WEIGHT: 0.548 kg</p>
	<p>NAME: Airtrac 6x6 main wheel mud-screen. PART NO.: A22LS-02-3007 R A22LS-02-3007 L WEIGHT: 0.5 kg</p>

Wheels / Колеса

	<p>NAME: Cheng shin 15x6x6 tyre and tube. PART NO.: A22LS-02-4001 WEIGHT: 2.662 kg</p>
	<p>НАИМЕН.: Шина Cheng shin 15x6x6 и камера. НОМЕР: A22LS-02-4001 ВЕС: 2.662 кг</p>
	<p>NAME: Airtrac 15x6x6 tyre and tube. PART NO.: A22LS-02-4002 WEIGHT: 3.183 kg</p>
	<p>НАИМЕН.: Шина Airtrac 15x6x6 и камера. НОМЕР: A22LS-02-4002 ВЕС: 3.183 кг</p>
	<p>NAME: Carlisle-Tyre 8x6 tyre and tube. PART NO.: A22LS-02-4003 WEIGHT: 4.223 kg</p>
	<p>НАИМЕН.: Шина Carlisle-Tyre 8x6 и камера. НОМЕР: A22LS-02-4003 ВЕС: 4.223 кг</p>
	<p>NAME: Airtrac 6x6 tyre and tube. PART NO.: A22LS-02-4007 WEIGHT: 3.05 kg</p>
	<p>НАИМЕН.: Шина Airtrac 6x6 и камера. НОМЕР: A22LS-02-4007 ВЕС: 3.05 кг</p>

	<p>NAME: Nose wheel. PART NO.: A22LS-02-4004 WEIGHT: 1.2 kg</p>
	<p>НАИМЕН.: Носовое колесо. НОМЕР: A22LS-02-4004 ВЕС: 1.2 кг</p>
	<p>NAME: Wheel with brake. PART NO.: A22LS-02-4005 WEIGHT: 1.621 kg</p>
	<p>НАИМЕН.: Тормозное колесо. НОМЕР: A22LS-02-4005 ВЕС: 1.621 кг</p>
	<p>NAME: Brake disk. PART NO.: A22LS-02-4006 WEIGHT: 0.393 kg</p>
	<p>НАИМЕН.: Тормозной диск. НОМЕР: A22LS-02-4006 ВЕС: 0.393 кг</p>

Brakes / Тормоза

 <p>The image shows a yellow master brake cylinder with a silver piston rod. A label on the cylinder reads: 'MATCO inc. PART # MC-4A (8011 335-0502) 2981 SOUTH 1560 WEST WOODS CROSS, UT 84087'. Below the cylinder are two fittings: a brass 90-degree elbow and a black plastic 90-degree elbow.</p>	<p>NAME: Master brake cylinder (yoke). PART NO.: A22LS-02-5000 WEIGHT: 0.2 kg</p> <hr/> <p>НАИМЕН.: Главный тормозной цилиндр (штурвал). НОМЕР: A22LS-02-5000 ВЕС: 0.2 кг</p>
 <p>The image shows a yellow master brake cylinder with a silver piston rod, similar to the yoke version. A label on the cylinder reads: 'MATCO inc. PART # MC-4A (8011 335-0502) 2981 SOUTH 1560 WEST WOODS CROSS, UT 84087'. Below the cylinder are two fittings: a brass 90-degree elbow and a black plastic 90-degree elbow.</p>	<p>NAME: Master brake cylinder (stick). PART NO.: A22LS-02-5004 WEIGHT: 0.2 kg</p> <hr/> <p>НАИМЕН.: Главный тормозной цилиндр (ручка). НОМЕР: A22LS-02-5004 ВЕС: 0.2 кг</p>
 <p>The image shows a set of five brass fittings: three 90-degree elbows and two straight connectors. Additionally, there is one black plastic 90-degree elbow and one brass T-fitting.</p>	<p>NAME: Brake system fittings (yoke, a set). PART NO.: A32-02-5000 WEIGHT: 0.124 kg</p> <hr/> <p>НАИМЕН.: Фитинги тормозной системы (штурвал, комплект). НОМЕР: A32-02-5000 ВЕС: 0.124 кг</p>
 <p>The image shows a set of five brass fittings: three 90-degree elbows and two straight connectors. Additionally, there is one black plastic 90-degree elbow and one brass T-fitting.</p>	<p>NAME: Brake system fittings (stick, a set). PART NO.: A22LS-02-5001 WEIGHT: 0.132 kg</p> <hr/> <p>НАИМЕН.: Фитинги тормозной системы (ручка, комплект). НОМЕР: A22LS-02-5001 ВЕС: 0.132 кг</p>

	<p>NAME: Braking system tubing (a set). PART NO.: A22LS-02-5002 WEIGHT: 0.25 kg</p>
	<p>НАИМЕН.: Трубка тормозной системы (комплект). НОМЕР: A22LS-02-5002 ВЕС: 0.25 кг</p>
	<p>NAME: Braking system expansion tank. PART NO.: A22LS-02-5003 WEIGHT: 0.04 kg</p>
	<p>НАИМЕН.: Тормозной расширительный бачок. НОМЕР: A22LS-02-5003 ВЕС: 0.04 кг</p>
	<p>NAME: SwiftLine Kit for WHLB3 Brakes. PART NO.: A22LS-02-5006 WEIGHT: 0.382 kg</p>
	<p>НАИМЕН.: Комплект тормозных колодок в сборе WHLB3. НОМЕР: A22LS-02-5006 ВЕС: 0.382 кг</p>

03. **ENGINE AND ITS SYSTEMS / ДВИГАТЕЛЬ И ЕГО СИСТЕМЫ****Engine mount / Моторама**

	<p>NAME: Engine mount (a set). PART NO.: A32-03-0001 WEIGHT: 7.42 kg</p>
	<p>NAME: Rubber shock absorbers (aircraft kit). Valid up to A32 S/N 119, A32L S/N 025 inclusive. PART NO.: A22LS-03-0002 WEIGHT: 0.468 kg</p>
	<p>NAME: Rubber shock absorbers with rivets (aircraft kit). Valid from A32 S/N 120, A32L S/N 026 inclusive. PART NO.: A32-03-0002 WEIGHT: 0.566 kg</p> <p>НАИМЕН.: Резиновые амортизаторы на заклепках (комплект на самолет). Действует с A32 S/N 120, A32L S/N 026 включительно. НОМЕР: A32-03-0002 ВЕС: 0.566 кг</p>

Control system / Система управления

	<p>NAME: Carburettor heating (a set). PART NO.: A32-03-1000 WEIGHT: 0.5 kg</p> <hr/> <p>НАИМЕН.: Обогрев карбюраторов (комплект). НОМЕР: A32-03-1000 ВЕС: 0.5 кг</p>
	<p>NAME: Sealing ring. PART NO.: A22LS-03-1001 WEIGHT: 0.005 kg</p> <hr/> <p>НАИМЕН.: Уплотнительное кольцо. НОМЕР: A22LS-03-1001 ВЕС: 0.005 кг</p>
	<p>NAME: R912UL/ULS/iS Bowden cable housing (right/left, stick). PART NO.: A32-03-1001 WEIGHT: 0.033 kg</p> <hr/> <p>НАИМЕН.: Боуден РУДа R912UL/ULS/iS (прав/лв ручка). НОМЕР: A32-03-1001 ВЕС: 0.033 кг</p>
	<p>NAME: R912UL/ULS throttle lever Bowden cable housing, right (yoke). PART NO.: A32-03-1002 WEIGHT: 0.077 kg</p> <hr/> <p>НАИМЕН.: Боуден РУДа R912UL/ULS правый (штурвал). НОМЕР: A32-03-1002 ВЕС: 0.077 кг</p>

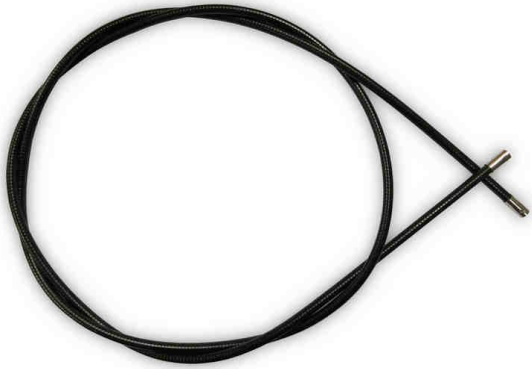
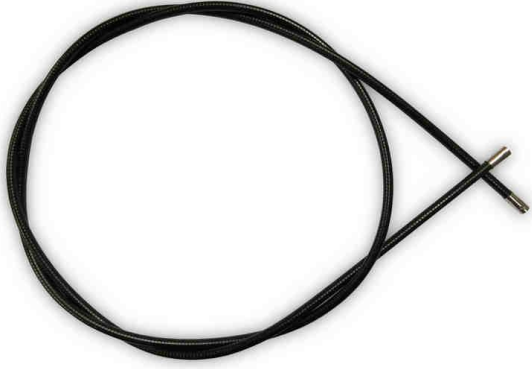
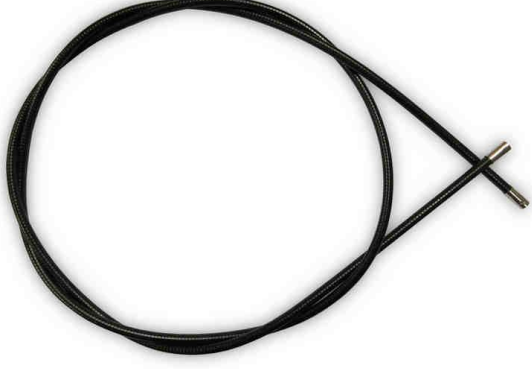
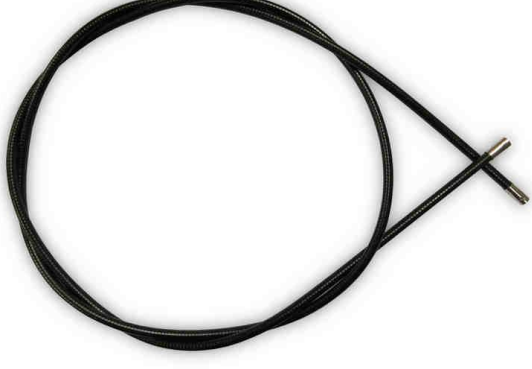
	<p>NAME: R912UL/ULS throttle lever Bowden cable housing, left (yoke). PART NO.: A32-03-1003 WEIGHT: 0.076 kg</p>
	<p>НАИМЕН.: Боуден РУДа R912UL/ULS левый (штурвал). НОМЕР: A32-03-1003 ВЕС: 0.076 кг</p>
	<p>NAME: R912iS throttle lever Bowden cable housing (yoke). PART NO.: A32-03-1004 WEIGHT: 0.084 kg</p>
	<p>НАИМЕН.: Боуден РУДа R912iS (штурвал). НОМЕР: A32-03-1004 ВЕС: 0.084 кг</p>
	<p>NAME: Choke Bowden cable housing (right/left, stick). PART NO.: A32-03-1005 WEIGHT: 0.073 kg</p>
	<p>НАИМЕН.: Боуден обогатителя (прлв ручка). НОМЕР: A32-03-1005 ВЕС: 0.073 кг</p>
	<p>NAME: Choke Bowden cable housing, right (yoke). PART NO.: A32-03-1006 WEIGHT: 0.079 kg</p>
	<p>НАИМЕН.: Боуден обогатителя правый (штурвал). НОМЕР: A32-03-1006 ВЕС: 0.079 кг</p>

	<p>NAME: Choke Bowden cable housing, left (yoke). PART NO.: A32-03-1007 WEIGHT: 0.074 kg</p>
	<p>НАИМЕН.: Боден обогатителя левый (штурвал). НОМЕР: A32-03-1007 ВЕС: 0.074 кг</p>
	<p>NAME: R912UL/ULS Bowden cable inner wire (right/left, stick). PART NO.: A32-03-1008 WEIGHT: 0.009 kg</p>
	<p>НАИМЕН.: Трос РУДа R912UL/ULS (пруть ручки). НОМЕР: A32-03-1008 ВЕС: 0.009 кг</p>
	<p>NAME: R912iS throttle lever Bowden cable inner wire (stick). PART NO.: A32-03-1009 WEIGHT: 0.009 kg</p>
	<p>НАИМЕН.: Трос РУДа R912iS (ручка). НОМЕР: A32-03-1009 ВЕС: 0.009 кг</p>
	<p>NAME: R912UL/ULS throttle lever Bowden cable inner wire, right (yoke). PART NO.: A32-03-1010 WEIGHT: 0.020 kg</p>
	<p>НАИМЕН.: Трос РУДа R912UL/ULS правый (штурвал). НОМЕР: A32-03-1010 ВЕС: 0.020 кг</p>

	<p>NAME: R912UL/ULS throttle lever Bowden cable inner wire, left (yoke). PART NO.: A32-03-1011 WEIGHT: 0.019 kg</p>
	<p>НАИМЕН.: Трос РУДа R912UL/ULS левый (штурвал). НОМЕР: A32-03-1011 ВЕС: 0.019 кг</p>
	<p>NAME: R912iS throttle lever Bowden cable inner wire (yoke). PART NO.: A32-03-1012 WEIGHT: 0.022 kg</p>
	<p>НАИМЕН.: Трос РУДа R912iS (штурвал). НОМЕР: A32-03-1012 ВЕС: 0.022 кг</p>
	<p>NAME: Choke Bowden cable inner wire (right/left, stick). PART NO.: A32-03-1013 WEIGHT: 0.017 kg</p>
	<p>НАИМЕН.: Трос обогатителя (прав/лев ручка). НОМЕР: A32-03-1013 ВЕС: 0.017 кг</p>
	<p>NAME: Choke Bowden cable inner wire, right (yoke). PART NO.: A32-03-1014 WEIGHT: 0.018 kg</p>
	<p>НАИМЕН.: Трос обогатителя правый (штурвал). НОМЕР: A32-03-1014 ВЕС: 0.018 кг</p>

	<p>NAME: Choke Bowden cable inner wire, left (yoke). PART NO.: A32-03-1015 WEIGHT: 0.017 kg</p>
	<p>НАИМЕН.: Трос обогатителя левый (штурвал). НОМЕР: A32-03-1015 ВЕС: 0.017 кг</p>

Fuel system / Топливная система

	<p>NAME: Sediment container. Valid from A32 S/N 033, A32L S/N 008 inclusive. PART NO.: A32-03-2000 WEIGHT: 0.084 kg</p> <hr/> <p>НАИМЕН.: Отстойник. Действует с A32 S/N 033, A32L S/N 008 включительно. НОМЕР: A32-03-2000 ВЕС: 0.084 кг</p>
	<p>NAME: Fuel filter. PART NO.: A22LS-03-2001 WEIGHT: 0.01 kg</p> <hr/> <p>НАИМЕН.: Топливный фильтр. НОМЕР: A22LS-03-2001 ВЕС: 0.01 кг</p>
	<p>NAME: 5-year rubber parts replacement kit. Without ROTAX parts. PART NO.: A32-03-2001 WEIGHT: 2.268 kg</p> <hr/> <p>НАИМЕН.: Комплект для замены резиновых частей по 5-ти летнему сроку. Без частей ROTAX. НОМЕР: A32-03-2001 ВЕС: 2.268 кг</p>

Oil system / Маслосистема



	NAME: Hoses and fitting of oil system (set). PART NO.: A32-03-3001 WEIGHT: 0.602 kg
	НАИМЕН.: Шланги и фитинги маслосистемы (комплект). НОМЕР: A32-03-3001 ВЕС: 0.602 кг





Cooling system / Система охлаждения

	<p>NAME: R912UL/ULS cooling system hoses (a set). PART NO.: A32-03-4000 WEIGHT: 0.899 kg</p> <hr/> <p>НАИМЕН.: Патрубки системы охлаждения R912UL/ULS (комплект). НОМЕР: A32-03-4000 ВЕС: 0.899 кг</p>
	<p>NAME: R912iS cooling system hoses (a set). PART NO.: A32-03-4002 WEIGHT: 0.848 kg</p> <hr/> <p>НАИМЕН.: Патрубки системы охлаждения R912iS (комплект). НОМЕР: A32-03-4002 ВЕС: 0.848 кг</p>
	<p>NAME: Radiator shutter assembly. PART NO.: A32-03-4001 WEIGHT: 0.296 kg</p> <hr/> <p>НАИМЕН.: Жалюзи радиатора в сборе. НОМЕР: A32-03-4001 ВЕС: 0.296 кг</p>

Exhaust system / Выхлопная система

	<p>NAME: Exhaust system with Rotax exhaust muffler (a set: pipes without holes, without threaded bushings for exhaust gas temperature sensors). Provide S/N. PART NO.: A32-03-5000 WEIGHT: 4.295 kg</p> <p>НАИМЕН.: Выхлопная система с глушителем Rotax (комплект: патрубки без отв., без резьбовых втулок под датчики температуры выхлопных газов). Сообщите S/N. НОМЕР: A32-03-5000 ВЕС: 4.295 кг</p>
	<p>NAME: Rotax exhaust muffler assembly. Provide S/N. PART NO.: A32-03-5001 WEIGHT: 2.57 kg</p> <p>НАИМЕН.: Глушитель Rotax в сборе. Сообщите S/N. НОМЕР: A32-03-5001 ВЕС: 2.57 кг</p>
	<p>NAME: Cyl. 1 exhaust pipe for Rotax exhaust muffler (without holes, without threaded bushings for exhaust gas temperature sensors). Provide S/N. PART NO.: A32-03-5002 WEIGHT: 0.474 kg</p> <p>НАИМЕН.: Выхлопной патрубок для глушителя Rotax 1-го цил. (без отв., без резьбовых втулок под датчики температуры выхлопных газов). Сообщите S/N. НОМЕР: A32-03-5002 ВЕС: 0.474 кг</p>
	<p>NAME: Cyl. 2 exhaust pipe for Rotax exhaust muffler (without holes, without threaded bushings for exhaust gas temperature sensors). Provide S/N. PART NO.: A32-03-5003 WEIGHT: 0.461 kg</p> <p>НАИМЕН.: Выхлопной патрубок для глушителя Rotax 2-го цил. (без отв., без резьбовых втулок под датчики температуры выхлопных газов). Сообщите S/N. НОМЕР: A32-03-5003 ВЕС: 0.461 кг</p>

	<p>NAME: Cyl. 3 exhaust pipe for Rotax exhaust muffler (without holes, without threaded bushings for exhaust gas temperature sensors). Provide S/N. PART NO.: A32-03-5004 WEIGHT: 0.299 kg</p>
	<p>NAME: Cyl. 4 exhaust pipe for Rotax exhaust muffler (without holes, without threaded bushings for exhaust gas temperature sensors). Provide S/N. PART NO.: A32-03-5005 WEIGHT: 0.323 kg</p>
	<p>NAME: Springs for the exhaust system with Rotax exhaust muffler (a set). Provide S/N. PART NO.: A22LS-03-5006 WEIGHT: 0.168 kg</p>
	<p>NAME: Exhaust system with Aeroweld exhaust muffler (a set: pipes without holes, without threaded bushings for exhaust gas temperature sensors). Provide S/N. PART NO.: A32-03-5006 WEIGHT: 3.897 kg</p>
	<p>НАИМЕН.: Выхлопной патрубок для глушителя Rotax 3-го цил. (без отв., без резьбовых втулок под датчики температуры выхлопных газов). Сообщите S/N. НОМЕР: A32-03-5004 ВЕС: 0.299 кг</p>
	<p>НАИМЕН.: Выхлопной патрубок для глушителя Rotax 4-го цил. (без отв., без резьбовых втулок под датчики температуры выхлопных газов). Сообщите S/N. НОМЕР: A32-03-5005 ВЕС: 0.323 кг</p>
	<p>НАИМЕН.: Пружины выхлопной системы с глушителем Rotax (комплект). Сообщите S/N. НОМЕР: A22LS-03-5006 ВЕС: 0.168 кг</p>
	<p>НАИМЕН.: Выхлопная система с глушителем Aeroweld (комплект: патрубки без отв., без резьбовых втулок под датчики температуры выхлопных газов). Сообщите S/N. НОМЕР: A32-03-5006 ВЕС: 3.897 кг</p>

	<p>NAME: Aeroweld exhaust muffler assembly. Provide S/N. PART NO.: A32-03-5007 WEIGHT: 2.078 kg</p>
	<p>НАИМЕН.: Глушитель Aeroweld в сборе. Сообщите S/N. НОМЕР: A32-03-5007 ВЕС: 2.078 кг</p>
	<p>NAME: Cyl. 1 exhaust pipe for Aeroweld exhaust muffler (without holes, without threaded bushings for exhaust gas temperature sensors). Provide S/N. PART NO.: A32-03-5008 WEIGHT: 0.51 kg</p>
	<p>НАИМЕН.: Выхлопной патрубок для глушителя Aeroweld 1-го цил. (без отв., без резьбовых втулок под датчики температуры выхлопных газов). Сообщите S/N. НОМЕР: A32-03-5008 ВЕС: 0.51 кг</p>
	<p>NAME: Cyl. 2 exhaust pipe for Aeroweld exhaust muffler (without holes, without threaded bushings for exhaust gas temperature sensors). Provide S/N. PART NO.: A32-03-5009 WEIGHT: 0.494 kg</p>
	<p>НАИМЕН.: Выхлопной патрубок для глушителя Aeroweld 2-го цил. (без отв., без резьбовых втулок под датчики температуры выхлопных газов). Сообщите S/N. НОМЕР: A32-03-5009 ВЕС: 0.494 кг</p>
	<p>NAME: Cyl. 3 exhaust pipe for Aeroweld exhaust muffler (without holes, without threaded bushings for exhaust gas temperature sensors). Provide S/N. PART NO.: A32-03-5010 WEIGHT: 0.35 kg</p>
	<p>НАИМЕН.: Выхлопной патрубок для глушителя Aeroweld 3-го цил. (без отв., без резьбовых втулок под датчики температуры выхлопных газов). Сообщите S/N. НОМЕР: A32-03-5010 ВЕС: 0.35 кг</p>

	<p>NAME: Cyl. 4 exhaust pipe for Aeroweld exhaust muffler (without holes, without threaded bushings for exhaust gas temperature sensors). Provide S/N. PART NO.: A32-03-5011 WEIGHT: 0.329 kg</p>
	<p>НАИМЕН.: Выхлопной патрубок для глушителя Aeroweld 4-го цил. (без отв., без резьбовых втулок под датчики температуры выхлопных газов). Сообщите S/N. НОМЕР: A32-03-5011 ВЕС: 0.329 кг</p>
	<p>NAME: Springs for the exhaust system with Aeroweld exhaust muffler (a set). Provide S/N. PART NO.: A22LS-03-5014 WEIGHT: 0.136 kg</p>
	<p>НАИМЕН.: Пружины выхлопной системы с глушителем Aeroweld (комплект). Сообщите S/N. НОМЕР: A22LS-03-5014 ВЕС: 0.136 кг</p>
	<p>NAME: EGT sensor fittings, M8x1 inner thread (a set). PART NO.: A22LS-03-5007 WEIGHT: 0.05 kg</p>
	<p>НАИМЕН.: Втулки под датчики EGT, внутренняя резьба M8x1 (комплект). НОМЕР: A22LS-03-5007 ВЕС: 0.05 кг</p>

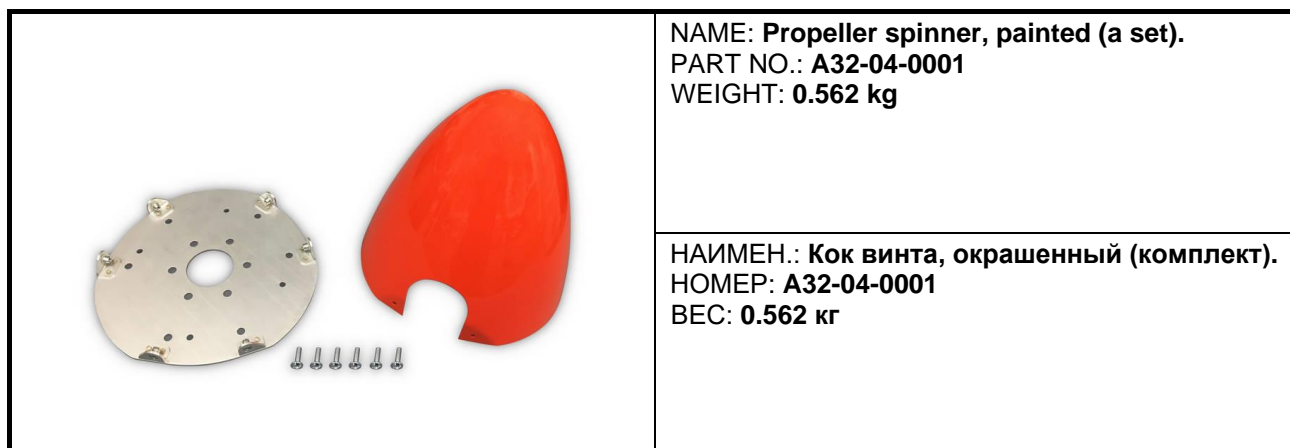
04. PROPELLER / ВОЗДУШНЫЙ ВИНТ**Spinner / Кок**

Propeller / Винт

	<p>NAME: KievProp propeller 263/1700 (a set). PART NO.: A22LS-04-1000 WEIGHT: 4.068 kg</p>
	<p>NAME: KievProp propeller 283/1800 (a set). PART NO.: A22LS-04-1001 WEIGHT: 4.329 kg</p>
	<p>НАИМЕН.: Воздушный винт KievProp 263/1700 (комплект). НОМЕР: A22LS-04-1000 ВЕС: 4.068 кг</p> <p>НАИМЕН.: Воздушный винт KievProp 283/1800 (комплект). НОМЕР: A22LS-04-1001 ВЕС: 4.329 кг</p>

05. AIRPLANE CONTROL SYSTEM / СИСТЕМА УПРАВЛЕНИЯ САМОЛЕТОМ

Control system levers / Посты системы управления

 <p>IMAGE COMING SOON</p>	<p>NAME: I-stick column with button. PART NO.: A32-05-0001 WEIGHT: 0.426 kg</p>
	<p>НАИМЕН.: Колонка I-ручки с кнопкой. НОМЕР: A32-05-0001 ВЕС: 0.426 кг</p>
 <p>IMAGE COMING SOON</p>	<p>NAME: Y-stick column with buttons. PART NO.: A32-05-0002 WEIGHT: 0.545 kg</p>
	<p>НАИМЕН.: Колонка Y-ручки с кнопками. НОМЕР: A32-05-0002 ВЕС: 0.545 кг</p>
	<p>NAME: I-stick upper cover with fasteners. PART NO.: A32-05-0003 WEIGHT: 0.1 kg</p>
	<p>НАИМЕН.: Чехол верхний для I-ручки с крепежом. НОМЕР: A32-05-0003 ВЕС: 0.1 кг</p>
	<p>NAME: Y-stick upper cover with fasteners. PART NO.: A32-05-0004 WEIGHT: 0.107 kg</p>
	<p>НАИМЕН.: Чехол верхний для Y-ручки с крепежом. НОМЕР: A32-05-0004 ВЕС: 0.107 кг</p>

	<p>NAME: Lower cover. PART NO.: A32-05-0005 WEIGHT: 0.037 kg</p>
	<p>НАИМЕН.: Чехол нижний. НОМЕР: A32-05-0005 ВЕС: 0.037 кг</p>
	<p>NAME: Stick column stop. PART NO.: A32-05-0006 WEIGHT: 0.411 kg</p>
	<p>НАИМЕН.: Фиксатор колонки ручки. НОМЕР: A32-05-0006 ВЕС: 0.411 кг</p>
	<p>NAME: Yoke assembly with one button (right). PART NO.: A32-05-0007 WEIGHT: 1.051 kg</p>
	<p>НАИМЕН.: Штурвал в сборе с одной кнопкой (правый). НОМЕР: A32-05-0007 ВЕС: 1.051 кг</p>
	<p>NAME: Yoke assembly with one button (left). PART NO.: A32-05-0008 WEIGHT: 1.048 kg</p>
	<p>НАИМЕН.: Штурвал в сборе с одной кнопкой (левый). НОМЕР: A32-05-0008 ВЕС: 1.048 кг</p>





	<p>NAME: Yoke assembly with two buttons (right). PART NO.: A32-05-0009 WEIGHT: 1.073 kg</p>
	<p>НАИМЕН.: Штурвал в сборе с двумя кнопками (правый). НОМЕР: A32-05-0009 ВЕС: 1.073 кг</p>
	<p>NAME: Yoke supports (nylon). PART NO.: A32-05-0010 WEIGHT: 1.070 kg</p>
	<p>НАИМЕН.: Штурвал в сборе с двумя кнопками (левый). НОМЕР: A32-05-0010 ВЕС: 1.070 кг</p>
	<p>NAME: Yoke supports (nylon). PART NO.: A32-05-0011 WEIGHT: 0.082 kg</p>
	<p>НАИМЕН.: Опоры штурвалов (капролон). НОМЕР: A32-05-0011 ВЕС: 0.082 кг</p>
	<p>NAME: Yoke supports (fluoroplast). PART NO.: A32-05-0012 WEIGHT: 0.084 kg</p>
	<p>НАИМЕН.: Опоры штурвалов (фторопласт). НОМЕР: A32-05-0012 ВЕС: 0.084 кг</p>

	<p>NAME: Neutral stop support. PART NO.: A32-05-0013 WEIGHT: 0.018 kg</p>
	<p>НАИМЕН.: Опора фиксатора нейтралн. НОМЕР: A32-05-0013 ВЕС: 0.018 кг</p>
	<p>NAME: Yoke neutral stop. PART NO.: A22LS-05-0011 WEIGHT: 0.021 kg</p>
	<p>НАИМЕН.: Фиксатор нейтралн штурвалов. НОМЕР: A22LS-05-0011 ВЕС: 0.021 кг</p>
	<p>NAME: Handle (1pc.) for I(Y)-stick, yoke, flap lever. PART NO.: A22LS-05-0012 WEIGHT: 0.009 kg</p>
	<p>НАИМЕН.: Рукоятка (1шт) для I-ручки, штурвалов, рычага закрылков. НОМЕР: A22LS-05-0012 ВЕС: 0.009 кг</p>
	<p>NAME: Ø16x17 handle for control levers of trim tab, choke, parking brake. PART NO.: A22LS-05-0014 WEIGHT: 0.003 kg</p>
	<p>НАИМЕН.: Рукоятка Ø16x17 рычагов триммера, обогатителя, стояночного тормоза. НОМЕР: A22LS-05-0014 ВЕС: 0.003 кг</p>

	<p>NAME: $\varnothing 30 \times 43$ handle of throttle lever (yoke) right. PART NO.: A32-05-0014 WEIGHT: 0.028 kg</p>
	<p>NAME: $\varnothing 30 \times 43$ handle of throttle lever (yoke) left. PART NO.: A32-05-0015 WEIGHT: 0.011 kg</p>
	<p>NAME: $\varnothing 22 \times 25$ handle for brake lever (yoke). PART NO.: A22LS-05-0016 WEIGHT: 0.008 kg</p>
	<p>NAME: Plug $\varnothing 17.5$mm, blind. PART NO.: A22LS-05-0020 WEIGHT: 0.003 kg</p>
	<p>НАИМЕН.: Рукоятка $\varnothing 30 \times 43$ рычага управления двигателем (штурвал) правая. НОМЕР: A32-05-0014 ВЕС: 0.028 кг</p> <p>НАИМЕН.: Рукоятка $\varnothing 30 \times 15$ рычага управления двигателем (штурвал) левая. НОМЕР: A32-05-0015 ВЕС: 0.011 кг</p> <p>НАИМЕН.: Рукоятка $\varnothing 22 \times 25$ рычага тормоза (штурвал). НОМЕР: A22LS-05-0016 ВЕС: 0.008 кг</p> <p>НАИМЕН.: Заглушка $\varnothing 17.5$мм глухая. НОМЕР: A22LS-05-0020 ВЕС: 0.003 кг</p>





	<p>NAME: Plug Ø17.5mm, for button. PART NO.: A22LS-05-0021 WEIGHT: 0.002 kg</p>
	<p>NAME: Yoke covers set. PART NO.: A22LS-05-0022 WEIGHT: 0.051 kg</p>
	<p>NAME: Throttle control rod assembly. PART NO.: A32-05-0016 R A32-05-0016 L WEIGHT: 0.268 kg</p>
	<p>NAME: Throttle control rod pads kit. PART NO.: A32-05-0017 R A32-05-0017 L WEIGHT: 0.024 kg</p>
	<p>НАИМЕН.: Комплект накладок штока управления двигателем. НОМЕР: A32-05-0017 R A32-05-0017 L ВЕС: 0.024 кг</p>



Aileron control system / Система управления элеронами

	<p>NAME: Closing link L=630 mm. PART NO.: A32-05-1000 WEIGHT: 0.135 kg</p>
	<p>НАИМЕН.: Тяга замыкающая L=630 мм. НОМЕР: A32-05-1000 ВЕС: 0.135 кг</p>
	<p>NAME: Flaperon cables, yokes (a set). PART NO.: A32-05-1001 WEIGHT: 0.269 kg</p>
	<p>НАИМЕН.: Троса управления флаперонами, штурвал (комплект). НОМЕР: A32-05-1001 ВЕС: 0.269 кг</p>
	<p>NAME: Flaperon cables, stick (a set). PART NO.: A32-05-1002 WEIGHT: 0.235 kg</p>
	<p>НАИМЕН.: Троса управления флаперонами, ручка (комплект). НОМЕР: A32-05-1002 ВЕС: 0.235 кг</p>
	<p>NAME: Aileron control system pulley. PART NO.: A32-05-1003 WEIGHT: 0.038 kg</p>
	<p>НАИМЕН.: Ролик системы управления элеронами. НОМЕР: A32-05-1003 ВЕС: 0.038 кг</p>

 A silver-colored metal component with a complex, angular shape. It features two circular holes on the left side and a larger, irregularly shaped hole on the right side. The component appears to be a stop for a flap extension lever.	<p>NAME: Flap extension lever stop. PART NO.: A32-05-1004 WEIGHT: 0.057 kg</p>
 A silver-colored metal component consisting of a rectangular block with a cylindrical rod passing through it. The rod has a hexagonal head on the left and a hexagonal nut on the right. The block has a textured surface.	<p>NAME: Flap extension lever stop with fasteners. PART NO.: A32-05-1005 WEIGHT: 0.058 kg</p> <p>НАИМЕН.: Фиксатор рычага закрылков. НОМЕР: A32-05-1004 ВЕС: 0.057 кг</p> <p>НАИМЕН.: Ограничитель рычага закрылков с крепежом. НОМЕР: A32-05-1005 ВЕС: 0.058 кг</p>

Elevator control system / Система управления РВ

	<p>NAME: Stabilator push pull rod. PART NO.: A32-05-2000 WEIGHT: 0.267 kg</p>
	<p>НАИМЕН.: Тяга управления ЦПГО. НОМЕР: A32-05-2000 ВЕС: 0.267 кг</p>
	<p>NAME: Stabilator cables, yokes (a set). PART NO.: A32-05-2001 WEIGHT: 0.738 kg</p>
	<p>НАИМЕН.: Троса управления ЦПГО, штурвал (комплект). НОМЕР: A32-05-2001 ВЕС: 0.738 кг</p>
	<p>NAME: Stabilator cables, stick (a set). PART NO.: A32-05-2002 WEIGHT: 0.662 kg</p>
	<p>НАИМЕН.: Троса управления ЦПГО, ручка (комплект). НОМЕР: A32-05-2002 ВЕС: 0.662 кг</p>
	<p>NAME: Stabilator control system pulley with bearing. PART NO.: A32-05-2003 WEIGHT: 0.027 kg</p>
	<p>НАИМЕН.: Ролик системы управления ЦПГО с втулкой. НОМЕР: A32-05-2003 ВЕС: 0.027 кг</p>

	<p>NAME: Trim tab cables (set). PART NO.: A32-05-2004 WEIGHT: 0.092 kg</p>
	<p>НАИМЕН.: Троса триммера (комплект). НОМЕР: A32-05-2004 ВЕС: 0.092 кг</p>
	<p>NAME: Trim tab pushrod. PART NO.: A32-05-2005 WEIGHT: 0.051 kg</p>
	<p>НАИМЕН.: Тяга триммера. НОМЕР: A32-05-2005 ВЕС: 0.051 кг</p>
	<p>NAME: Trim tab pushrod spacers with fasteners. PART NO.: A32-05-2006 WEIGHT: 0.012 kg</p>
	<p>НАИМЕН.: Распорные втулки тяги триммера с крепежом. НОМЕР: A32-05-2006 ВЕС: 0.012 кг</p>

Rudder control system / Система управления РН

	<p>NAME: Rudder control cables (a set). PART NO.: A32-05-3000 WEIGHT: 0.421 kg</p>
	<p>НАИМЕН.: Троса управления руля направления (комплект). НОМЕР: A32-05-3000 ВЕС: 0.421 кг</p>
	<p>NAME: Rudder pedals bungees (a set). PART NO.: A32-05-3001 WEIGHT: 0.096 kg</p>
	<p>НАИМЕН.: Загрузатель педалей (комплект). НОМЕР: A32-05-3001 ВЕС: 0.096 кг</p>
	<p>NAME: Rudder control system pulley with bearing. PART NO.: A22LS-05-3008 WEIGHT: 0.025 kg</p>
	<p>НАИМЕН.: Ролик системы управления РН с втулкой. НОМЕР: A22LS-05-3008 ВЕС: 0.025 кг</p>

Autopilot / Автопилот





	<p>NAME: Dynon autopilot installation set. Valid up to A32 S/N 129, A32L S/N 025 inclusive. PART NO.: A32-05-4004 WEIGHT: 0.629 kg</p> <p>НАИМЕН.: Комплект для установки автопилота Дупон. Действует до A32 S/N 129, A32L S/N 025 включительно. НОМЕР: A32-05-4004 ВЕС: 0.629 кг</p>
	<p>NAME: Dynon autopilot installation set. Valid from A32 S/N 130, A32L S/N 026 inclusive. PART NO.: A32-05-4005 WEIGHT: 0.628 kg</p> <p>НАИМЕН.: Комплект для установки автопилота Дупон. Действует с A32 S/N 130, A32L S/N 026 включительно. НОМЕР: A32-05-4005 ВЕС: 0.628 кг</p>
	<p>NAME: Garmin autopilot installation set. Valid up to A32 S/N 129, A32L S/N 025 inclusive. PART NO.: A32-05-4006 WEIGHT: 0.657 kg</p> <p>НАИМЕН.: Комплект для установки автопилота Garmin. Действует до A32 S/N 129, A32L S/N 025 включительно. НОМЕР: A32-05-4006 ВЕС: 0.657 кг</p>
	<p>NAME: Garmin autopilot installation set. Valid from A32 S/N 130, A32L S/N 026 inclusive. PART NO.: A32-05-4007 WEIGHT: 0.656 kg</p> <p>НАИМЕН.: Комплект для установки автопилота Garmin. Действует с A32 S/N 130, A32L S/N 026 включительно. НОМЕР: A32-05-4007 ВЕС: 0.656 кг</p>

 A collection of metal parts for an MGL autopilot installation, including various brackets, plates, and long beams with mounting holes.	<p>NAME: MGL autopilot installation set. PART NO.: A32-05-4002 WEIGHT: 0.596 kg</p>
 A collection of metal parts for a Kanardia autopilot installation, including various brackets, plates, and long beams with mounting holes, similar to the MGL set but with different part numbers.	<p>NAME: Kanardia autopilot installation set. PART NO.: A32-05-4003 WEIGHT: 0.588 kg</p> <p>НАИМЕН.: Комплект для установки автопилота MGL. НОМЕР: A32-05-4002 ВЕС: 0.596 кг</p> <p>НАИМЕН.: Комплект для установки автопилота Kanardia. НОМЕР: A32-05-4003 ВЕС: 0.588 кг</p>





06. ELECTRICAL SYSTEM / ЭЛЕКТРОСИСТЕМА

Electrical equipment / Электрооборудование

	<p>NAME: GR-40X landing light (a set for T1110 light replacement). Valid up to A32 S/N 099, A32L S/N 024 inclusive. PART NO.: A22LS-06-0001 WEIGHT: 0.438 kg</p>
	<p>NAME: GR-40X landing light. Valid from A32 S/N 100, A32L S/N 025 inclusive. PART NO.: A22LS-06-0008 WEIGHT: 0.412 kg</p>
	<p>NAME: Condenser 22000 μF 25V. PART NO.: A22LS-06-0002 WEIGHT: 0.093 kg</p>
	<p>NAME: Switch guard. PART NO.: A22LS-06-0003 WEIGHT: 0.005 kg</p>
	<p>НАИМЕН.: Защитная планка. НОМЕР: A22LS-06-0003 ВЕС: 0.005 кг</p>

	<p>NAME: Toggle switch. PART NO.: A22LS-06-0004 WEIGHT: 0.021 kg</p>
	<p>НАИМЕН.: Тумблер. НОМЕР: A22LS-06-0004 ВЕС: 0.021 кг</p>
	<p>NAME: Battery straps (a set). PART NO.: A22LS-06-0005 WEIGHT: 0.024 kg</p>
	<p>НАИМЕН.: Ремни аккумулятора (комплект). НОМЕР: A22LS-06-0005 ВЕС: 0.024 кг</p>
	<p>NAME: Li-Ion battery strap. PART NO.: A22LS-06-0007 WEIGHT: 0.012 kg</p>
	<p>НАИМЕН.: Ремень Li-Ion аккумулятора. НОМЕР: A22LS-06-0007 ВЕС: 0.012 кг</p>
	<p>NAME: Fuel level sensor sealing ring. Valid up to A32 S/N 073, A32L S/N 022 inclusive. PART NO.: A22LS-06-0006 WEIGHT: 0.009 kg</p>
	<p>НАИМЕН.: Уплотнение датчика уровня топлива. Действует до A32 S/N 073, A32L S/N 022 включительно. НОМЕР: A22LS-06-0006 ВЕС: 0.009 кг</p>

Instruments / Приборное оборудование

	<p>NAME: Airspeed indicator (specify the model by the serial number of the aircraft), range: 0-240 kph, size: 3-1/8" (range markings not included). PART NO.: A22LS-06-1000 WEIGHT: 0.29 kg</p>
	<p>NAME: Airspeed indicator (specify the model by the serial number of the aircraft), range: 20-140 knots, size: 3-1/8" (range markings not included). PART NO.: A22LS-06-1001 WEIGHT: 0.37 kg</p>
	<p>НАИМЕН.: Указатель скорости (модель уточняйте по серийному номеру самолёта), диапазон: 20-140 узлов, размер: Ø80 мм (без маркировки диапазона). НОМЕР: A22LS-06-1001 ВЕС: 0.37 кг</p>
	<p>NAME: Altimeter (specify the model by the serial number of the aircraft), range: 20000 feet, mbar, size: 3-1/8". PART NO.: A22LS-06-1002 WEIGHT: 0.525 kg</p>
	<p>NAME: Vertical speed indicator (specify the model by the serial number of the aircraft), range: +/-2000 feet/min, size: 3-1/8". PART NO.: A22LS-06-1003 WEIGHT: 0.343 kg</p>
	<p>НАИМЕН.: Вариометр (модель уточняйте по серийному номеру самолёта), диапазон: +/-2000 футов/мин, размер: Ø80 мм. НОМЕР: A22LS-06-1003 ВЕС: 0.343 кг</p>

	<p>NAME: Compass, size: 2-1/4". PART NO.: A22LS-06-1004 WEIGHT: 0.27 kg</p>
	<p>NAME: Compass. PART NO.: A22LS-06-1005 WEIGHT: 0.3 kg</p>
	<p>NAME: Slip indicator Winter QM II. PART NO.: A22LS-06-1008 WEIGHT: 0.045 kg</p>
	<p>NAME: Fuel level indicator (specify the model by the serial number of the aircraft), size: 2-1/16". PART NO.: A22LS-06-1007 WEIGHT: 0.1 kg</p>
	<p>НАИМЕН.: Индикатор уровня топлива (модель уточняйте по серийному номеру самолёта), размер: Ø52 мм. НОМЕР: A22LS-06-1007 ВЕС: 0.1 кг</p>

07. СОСКРИТ EQUIPMENT / ОБОРУДОВАНИЕ КАБИНЫ

Seats / Сиденья

	<p>NAME: Standard seat assembly. PART NO.: A32-07-0004 WEIGHT: 2.7 kg</p>
	<p>НАИМЕН.: Сиденье стандартное в сборе. НОМЕР: A32-07-0004 ВЕС: 2.7 кг</p>
	<p>NAME: Standard seat framework. PART NO.: A32-07-0002 WEIGHT: 1.708 kg</p>
	<p>НАИМЕН.: Каркас сиденья стандартного. НОМЕР: A32-07-0002 ВЕС: 1.708 кг</p>
	<p>NAME: Standard seat cushion. PART NO.: A32-07-0003 WEIGHT: 0.992 kg</p>
	<p>НАИМЕН.: Подушка сиденья стандартного. НОМЕР: A32-07-0003 ВЕС: 0.992 кг</p>
	<p>NAME: Tall pilot seat assembly. PART NO.: A32-07-0005 WEIGHT: 3.23 kg</p>
	<p>НАИМЕН.: Сиденье для высокого пилота в сборе. НОМЕР: A32-07-0005 ВЕС: 3.23 кг</p>

	<p>NAME: Tall pilot seat framework. PART NO.: A32-07-0006 WEIGHT: 2.14 kg</p>
	<p>НАИМЕН.: Каркас сиденья для высокого пилота. НОМЕР: A32-07-0006 ВЕС: 2.14 кг</p>
	<p>NAME: Tall pilot seat cushion. PART NO.: A32-07-0007 WEIGHT: 1.09 kg</p>
	<p>НАИМЕН.: Подушка сиденья для высокого пилота. НОМЕР: A32-07-0007 ВЕС: 1.09 кг</p>





Harness belts / Привязная система



	<p>NAME: Harness belts (a set for 2 pilots). PART NO.: A32-07-1000 WEIGHT: 1.3 kg</p>
	<p>НАИМЕН.: Привязные ремни (комплект для 2-х пилотов). НОМЕР: A32-07-1000 ВЕС: 1.3 кг</p>

Interior and baggage compartment / Интерьер и багажник

 IMAGE COMING SOON	NAME: Ceiling panels, with fasteners, unpainted. PART NO.: A32-07-4000 WEIGHT: 2.354 kg
	НАИМЕН.: Панели потолка, с крепежом, неокрашенные. НОМЕР: A32-07-4000 ВЕС: 2.354 кг
 IMAGE COMING SOON	NAME: Ceiling panels, with fasteners, painted. Provide S/N. PART NO.: A32-07-4001 WEIGHT: 2.459 kg
	НАИМЕН.: Панели потолка, с крепежом, окрашенные. Сообщите S/N. НОМЕР: A32-07-4001 ВЕС: 2.459 кг

08. CONSUMABLE MATERIALS / РАСХОДНЫЕ МАТЕРИАЛЫ

	<p>NAME: ATF hydraulic fluid, 5 l. PART NO.: A22LS-08-0001 WEIGHT: 4.5 kg</p> <hr/> <p>НАИМЕН.: Жидкость гидравлическая ATF, 5 л. НОМЕР: A22LS-08-0001 ВЕС: 4.5 кг</p>
	<p>NAME: Mobil 1 (5W-50) engine oil, 4 l. PART NO.: A22LS-08-0002 WEIGHT: 3.6 kg</p> <hr/> <p>НАИМЕН.: Моторное масло Mobil 1 (5W-50), 4 л. НОМЕР: A22LS-08-0002 ВЕС: 3.6 кг</p>
	<p>NAME: Mobil antifreeze (concentrated), 5 l. PART NO.: A22LS-08-0003 WEIGHT: 5.5 kg</p> <hr/> <p>НАИМЕН.: Антифриз Mobil (концентрат), 5 л. НОМЕР: A22LS-08-0003 ВЕС: 5.5 кг</p>
	<p>NAME: 3M polyurethane sealant, 310 ml. PART NO.: A22LS-08-1000 WEIGHT: 0.35 kg</p> <hr/> <p>НАИМЕН.: Герметик полиуретановый 3М, 310 мл. НОМЕР: A22LS-08-1000 ВЕС: 0.35 кг</p>

	<p>NAME: Acrylic sealant for glazing. PART NO.: A22LS-08-1001 WEIGHT: 0.3 kg</p>
	<p>НАИМЕН.: Герметик акриловый для уплотнения остекления. НОМЕР: A22LS-08-1001 ВЕС: 0.3 кг</p>
	<p>NAME: Terostat-8517H primer, 25 ml. PART NO.: A22LS-08-2000 WEIGHT: 0.06 kg</p>
	<p>НАИМЕН.: Грунт Terostat - 8517H, 25 мл. НОМЕР: A22LS-08-2000 ВЕС: 0.06 кг</p>
	<p>NAME: Glasurit primer, 0.5 l + 1.0 l. PART NO.: A22LS-08-2001 WEIGHT: 1.75 kg</p>
	<p>НАИМЕН.: Грунт Glasurit, 0.5 л + 1.0 л. НОМЕР: A22LS-08-2001 ВЕС: 1.75 кг</p>
	<p>NAME: EcoFill primer, 3.8 l. PART NO.: A22LS-08-2002 WEIGHT: 4.9 kg</p>
	<p>НАИМЕН.: Грунт EcoFill, 3.8 л. НОМЕР: A22LS-08-2002 ВЕС: 4.9 кг</p>

CATALOG STRUCTURE / СТРУКТУРА КАТАЛОГА

A32 (A32L)

01 - AIRFRAME / ПЛАНЕР

- 0001 - 0999 - **Fuselage** / Фюзеляж
- 1000 - 1999 - **Wing** / Крыло
- 2000 - 2999 - **Horizontal empennage** / Горизонтальное оперение
- 3000 - 3999 - **Vertical empennage** / Вертикальное оперение
- 4000 - 4999 - **Glass** / Остекление
- 5000 - 5999 - **Doors** / Двери

02 - LANDING GEAR / ШАССИ

- 0001 - 0999 - **Nose leg** / Передняя стойка
- 1000 - 1999 - **Main leg** / Основная стойка
- 2000 - 2999 - **Fairings** / Обтекатели
- 3000 - 3999 - **Mud-screens** / Щитки
- 4000 - 4999 - **Wheels** / Колеса
- 5000 - 5999 - **Brakes** / Тормоза

03 - ENGINE AND ITS SYSTEMS / ДВИГАТЕЛЬ И ЕГО СИСТЕМЫ

- 0001 - 0999 - **Engine mount** / Моторама
- 1000 - 1999 - **Control system** / Система управления
- 2000 - 2999 - **Fuel system** / Топливная система
- 3000 - 3999 - **Oil system** / Маслосистема
- 4000 - 4999 - **Cooling system** / Система охлаждения
- 5000 - 5999 - **Exhaust system** / Выхлопная система

04 - PROPELLER / ВОЗДУШНЫЙ ВИНТ

- 0001 - 0999 - **Spinner** / Кок
- 1000 - 1999 - **Propeller** / Винт

05 - AIRPLANE CONTROL SYSTEM / СИСТЕМА УПРАВЛЕНИЯ САМОЛЕТОМ

- 0001 - 0999 - **Control system levers** / Посты системы управления
- 1000 - 1999 - **Aileron control system** / Система управления элеронами
- 2000 - 2999 - **Elevator control system** / Система управления РУ
- 3000 - 3999 - **Rudder control system** / Система управления РН
- 4000 - 4999 - **Autopilot** / Автопилот

06 - ELECTRICAL SYSTEM / ЭЛЕКТРОСИСТЕМА

- 0001 - 0999 - **Electrical equipment** / Электрооборудование
- 1000 - 1999 - **Instruments** / Приборное оборудование

07 - COCKPIT EQUIPMENT / ОБОРУДОВАНИЕ КАБИНЫ

- 0001 - 0999 - **Seats** / Сиденья
- 1000 - 1999 - **Harness belts** / Привязная система
- 2000 - 2999 - **Heating** / Отопление
- 3000 - 3999 - **Instrument compartment** / Приборный отсек
- 4000 - 4999 - **Interior and baggage compartment** / Интерьер и багажник
- 5000 - 5999 - **Rescue system** / Спассистема

08 - CONSUMABLE MATERIALS / РАСХОДНЫЕ МАТЕРИАЛЫ

- 0001 - 0999 - **Oils and fluids** / Масла и жидкости систем
- 1000 - 1999 - **Sealants** / Герметики
- 2000 - 2999 - **Primers and paints** / Грунты и краски